

## LONDON COLLECTION

### SINGLE KNOB (TO BE PAIRED WITH SINGLE SDH)

2487503

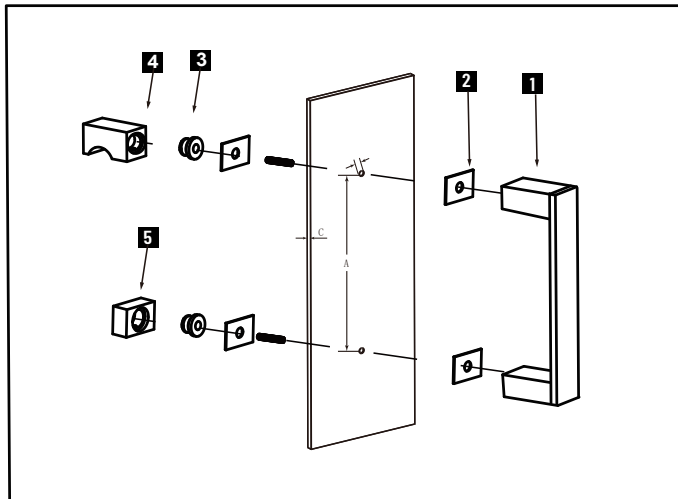
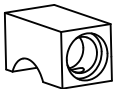

- 1.Handle x 1
- 2. Clear Gasket x 4
- 3. Fixing Bracket x 2
- 4.Knob x 1
- 5.End Cap x 1

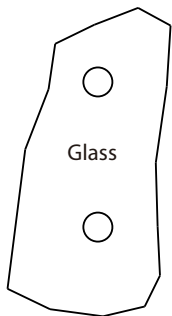

GLASS INFO		
A	1/2"(12mm)	Glass Hole Diameter
B	6-12mm	Glass Thickness

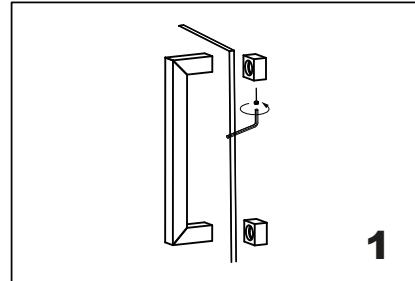

Loose the set screws, separate the handle and end caps.

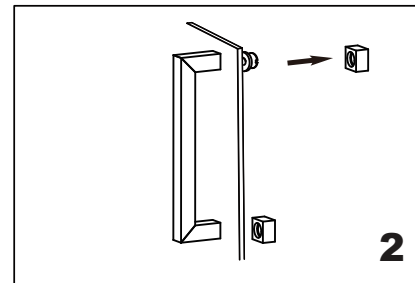

Remove the top end cap.

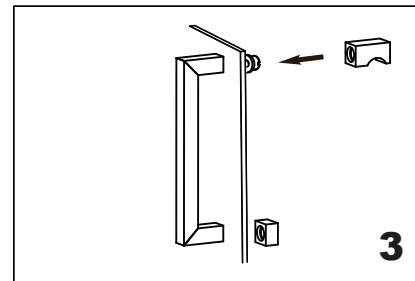

Add the 7503 knob on the fixing bracket,make sure the set screw hole in the bottom.

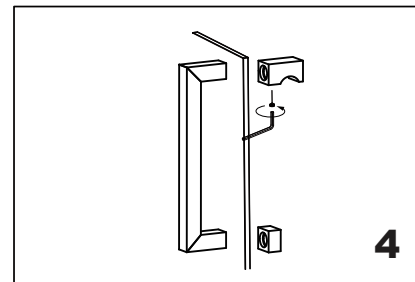

Fix the set screw on the end cap,tighten it to avoid loose from fixing brackets.